











32 815 861



- 235mm projection
- pivotable spout 360°
- Optional swivel limiter available with swivel limiter set 12 820 970 90
- air-enriched flow
- max. flow 8 l/min at 3 bar flow pressure
- This product can help a building meet the requirements of Green Building Rating Systems, e.g. LEED®, BREEAM®, DGNB
- lead-free

Operating unit can be positioned freely.

	Chrome	32 815 861-00
	Brushed Platinum	32 815 861-06
	Platinum	32 815 861-08
	Durabronze (23kt Gold)	32 815 861-09
	Dark Chrome	32 815 861-19
	Brushed Durabronze (23kt Gold)	32 815 861-28
	Matte Black	32 815 861-33
	Brushed Champagne (22kt Gold)	32 815 861-46
	Champagne (22kt Gold)	32 815 861-47
	Brushed Chrome	32 815 861-93
	Brushed Dark Platinum	32 815 861-99

Recommended miscellaneous

Swivel limitation set - 12 820 970 90



Recommended miscellaneous

Strainer waste with control handle - Chrome 10 710 970-00



Recommended miscellaneous

Dispenser with rosette - Chrome 82 444 970-00



32 815 861

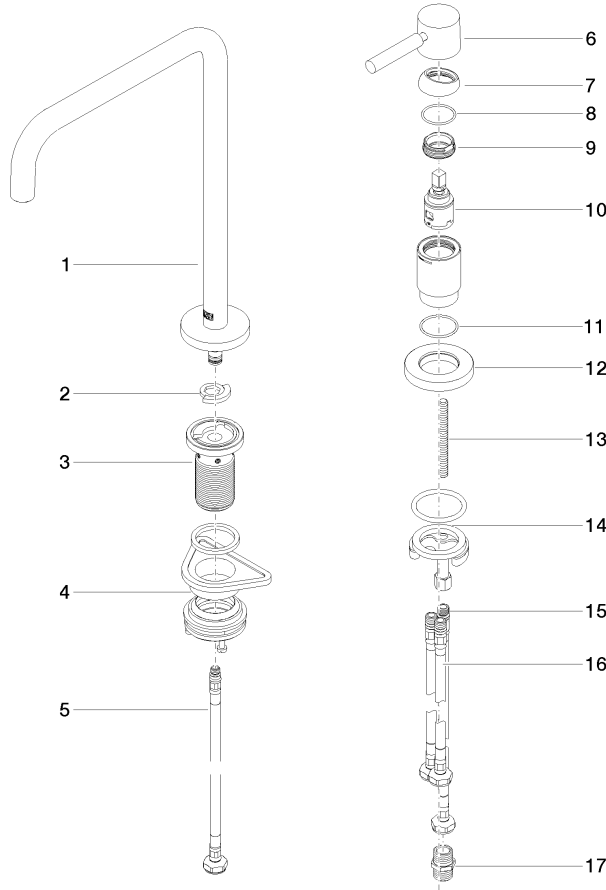

Spare parts list

No.	Item Number	Name	Quantity used	Delivery time
1	90 28 22 287 00-00	spout	1	-
Spare part can no longer be ordered, please order the replacement item				
2	12 820 970 90	Swivel limitation set -	1	2
3	90 30 01 299 00 90	shaft	1	2
4	04 23 10 044 08 90	fixing set	1	2
5	04 30 04 100 00 90	hose	1	2
6	90 20 66 003 00-00	handle	1	10
7	09 28 30 026-00	cover	1	10
8	09 14 10 091 90	seal	1	2
9	09 24 04 266 90	nut	1	2
10	90 15 05 042 00 90	cartridge	1	2
11	09 14 10 110 90	seal	1	2
12	09 27 97 040-00	rosette	1	10
13	09 31 11 011 90	pin	1	2
14	04 30 11 085 97 90	fixing set	1	2
15	04 30 04 104 00 90	hose	1	2
16	04 30 04 105 00 90	hose	2	2
17	90 24 03 250 00 90	nipple	1	2